

The RF Line

NPN Silicon

RF Power Transistor

TPV8100B

The TPV8100B is designed for output stages in band IV and V TV transmitter amplifiers. It incorporates high value emitter ballast resistors, gold metallizations and offers a high degree of reliability and ruggedness.

Including double input and output matching networks, the TPV8100B features high impedances. It can easily operate in a full 470 MHz to 860 MHz bandwidth in a single and simple circuit.

**150 W, 470–860 MHz
NPN SILICON
RF POWER TRANSISTOR**

- To be used class AB for TV band IV and V.
- Specified 28 Volts, 860 MHz Characteristics
Output Power = 125 Watts (peak sync.)
Output Power = 100 Watts (CW)
Minimum Gain = 8.5 dB
- Specified 32 Volts, 860 MHz Characteristics
Output Power = 150 Watts (peak sync.)
- Circuit board photomaster available upon request by contacting RF Tactical Marketing in Phoenix, AZ.

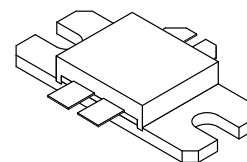

CASE 398-03, STYLE 1

MAXIMUM RATINGS

Rating	Symbol	Value	Unit
Collector–Emitter Voltage	V_{CER}	40	Vdc
Collector–Base Voltage	V_{CBO}	65	Vdc
Emitter–Base Voltage	V_{EBO}	4	Vdc
Collector–Current — Continuous	I_C	12	Adc
Total Device Dissipation @ 25°C Case Derate above 25°C	P_D	215 1.25	Watts W/°C
Operating Junction Temperature	T_J	200	°C
Storage Temperature Range	T_{stg}	–65 to +150	°C

THERMAL CHARACTERISTICS

Characteristic	Symbol	Max	Unit
Thermal Resistance, Junction to Case (1)	$R_{\theta JC}$	0.8	°C/W

ELECTRICAL CHARACTERISTICS ($T_C = 25^\circ\text{C}$ unless otherwise noted)

Characteristic	Symbol	Min	Typ	Max	Unit
----------------	--------	-----	-----	-----	------

OFF CHARACTERISTICS

Collector–Emitter Breakdown Voltage ($I_C = 10\text{ mA}$, $R_{be} = 75\ \Omega$)	$V_{(BR)CER}$	30	—	—	Vdc
Collector–Emitter Breakdown Voltage ($I_C = 10\text{ mAdc}$)	$V_{(BR)EBO}$	4	—	—	Vdc
Collector–Base Breakdown Voltage ($I_E = 20\text{ mAdc}$)	$V_{(BR)CBO}$	65	—	—	Vdc
Collector–Emitter Leakage ($V_{CE} = 28\text{ V}$, $R_{be} = 75\ \Omega$)	I_{CER}	—	—	10	mA

NOTE:

1. Thermal resistance is determined under specified RF operating condition.

(continued)

ELECTRICAL CHARACTERISTICS — continued ($T_C = 25^\circ\text{C}$ unless otherwise noted)

Characteristic	Symbol	Min	Typ	Max	Unit
ON CHARACTERISTICS					
DC Current Gain ($I_C = 2 \text{ Adc}$, $V_{CE} = 10 \text{ Vdc}$)	h_{FE}	30	—	120	—

DYNAMIC CHARACTERISTICS

Output Capacitance (each side) (2) ($V_{CB} = 28 \text{ V}$, $I_E = 0$, $f = 1 \text{ MHz}$)	C_{ob}	—	44	—	μF
---	----------	---	----	---	---------------

FUNCTIONAL TESTS IN CW (SOUND)

Common-Emitter Amplifier Power Gain ($V_{CC} = 28 \text{ V}$, $P_{out} = 100 \text{ W}$, $I_{CQ} = 2 \times 50 \text{ mA}$, $f = 860 \text{ MHz}$)	G_p	8.5	9.5	—	dB
Collector Efficiency ($V_{CC} = 28 \text{ V}$, $P_{out} = 100 \text{ W}$, $I_Q = 2 \times 50 \text{ mA}$, $f = 860 \text{ MHz}$)	η	55	58	—	%
Output Power @ 1 dB Compression ($P_{ref} = 25 \text{ W}$) ($V_{CC} = 28 \text{ V}$, $I_{CQ} = 2 \times 50 \text{ mA}$, $f = 860 \text{ MHz}$)	P_{out}	100	110	—	W

FUNCTIONAL TESTS IN VIDEO (STANDARD BLACK LEVEL)

Peak Output Power (synch.) ($V_{CC} = 28 \text{ V}$, $I_{CQ} = 2 \times 50 \text{ mA}$, $f = 860 \text{ MHz}$)	P_{out}	125	135	—	W
Peak Output Power (synch.) ($V_{CC} = 32 \text{ V}$, $I_{CQ} = 2 \times 25 \text{ mA}$, $f = 860 \text{ MHz}$)	P_{out}	150	160	—	W
Recommended Quiescent Current	I_{CQ}	—	—	2×0.3	A

NOTE:

2. Value of " C_{ob} " is that of die only. It is not measurable in TPV8100B because of internal matching network.

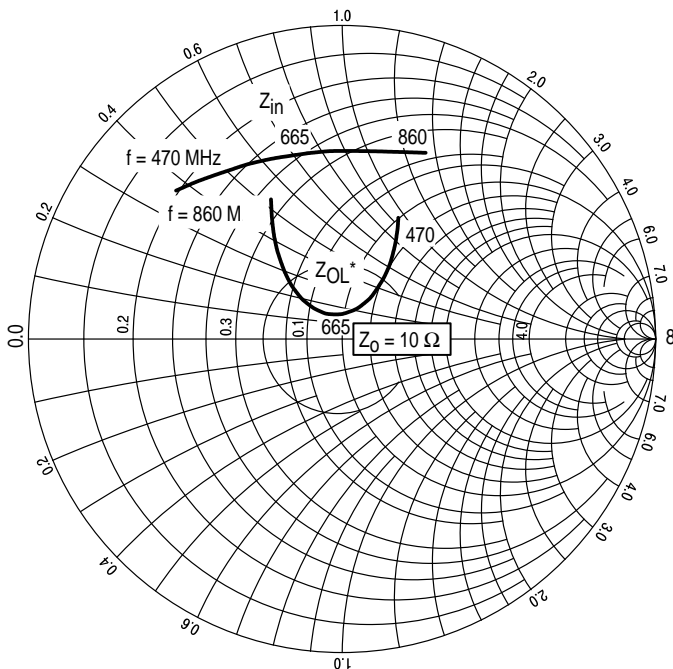

f (MHz)	Z_{in} (Ohms)	Z_{OL}^* (Ohms)
470	$1.95 + j3.67$	$10.0 + j9.50$
665	$3.65 + j6.82$	$9.23 + j1.30$
860	$6.66 + j13.8$	$4.45 + j5.22$

Z_{OL}^* = Conjugate of optimum load impedance into which the device operates at a given output power, voltage, current and frequency.

NOTE: Z_{in} & Z_{OL}^* are given from base-to-base and collector-to-collector respectively.

Input and Output impedances with circuit tuned for maximum linearity @ $V_{CC} = 28 \text{ V}$ / $I_{CQ} = 2 \times 50 \text{ mA}$ / $P_{out} = 100 \text{ W}$

Figure 1. Series Equivalent Input/Output Impedances

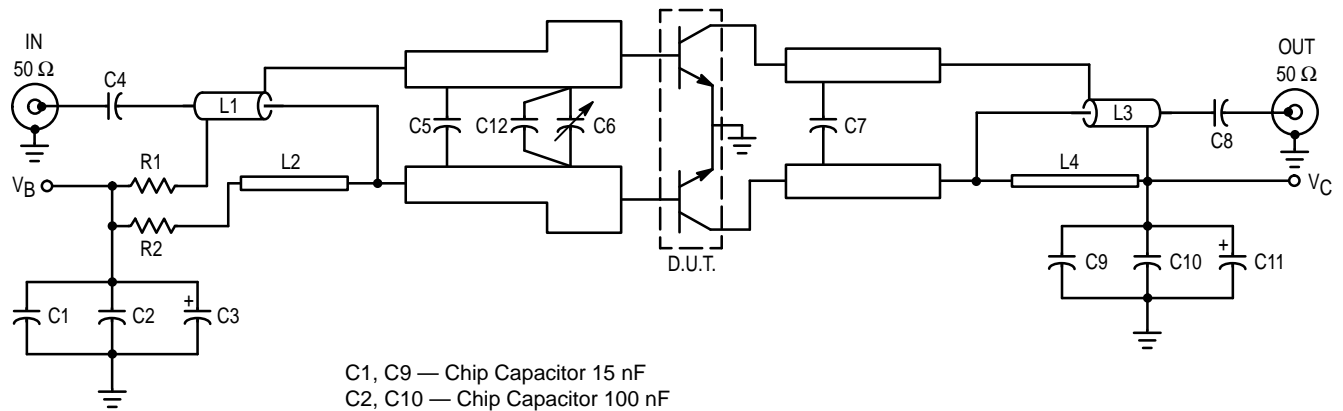

- C1, C9 — Chip Capacitor 15 nF
- C2, C10 — Chip Capacitor 100 nF
- C3, C11 — Chip Capacitor 100 μF/40 V
- C4 — Chip Capacitor 15 pF ATC 100A
- C5 — Chip Capacitor 5.6 pF ATC 100A
- C6 — Trimmer Capacitor 1–4 pF
- C7 — Chip Capacitor 12 pF ATC 100B
- C8 — Chip Capacitor 15 pF ATC 100A
- C12 — Chip Capacitor 12 pF ATC 100A
- L1, L3 — Coaxial Wire 25 Ω/85 Mils/40 mm
- L2, L4 — Printed Board Inductance
- R1, R2 — Chip Resistor 1 Ω 0805 5%

Figure 2. Test Circuit

TYPICAL CHARACTERISTICS
CW — WIDEBAND

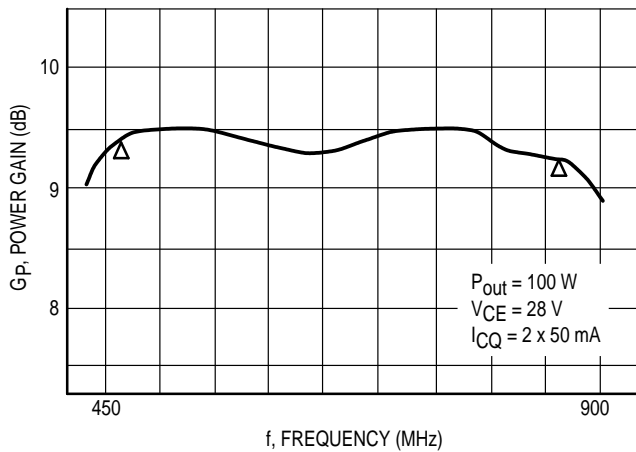

Figure 3. Power Gain versus Frequency

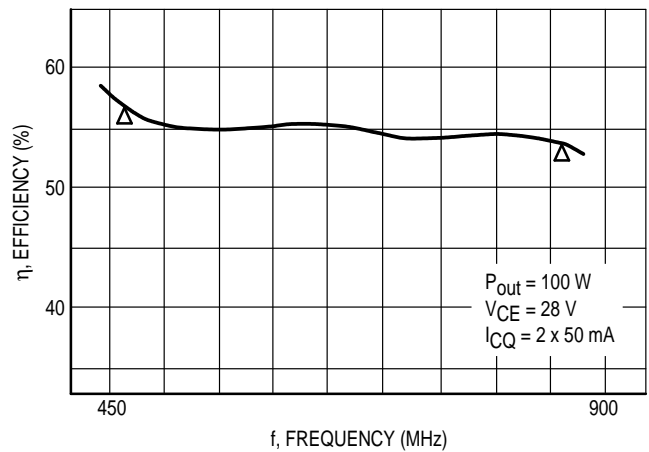

Figure 4. Collector Efficiency versus Frequency

TYPICAL VIDEO CHARACTERISTICS @ $f = 800$ MHz
 $V_{CE} = 28$ V

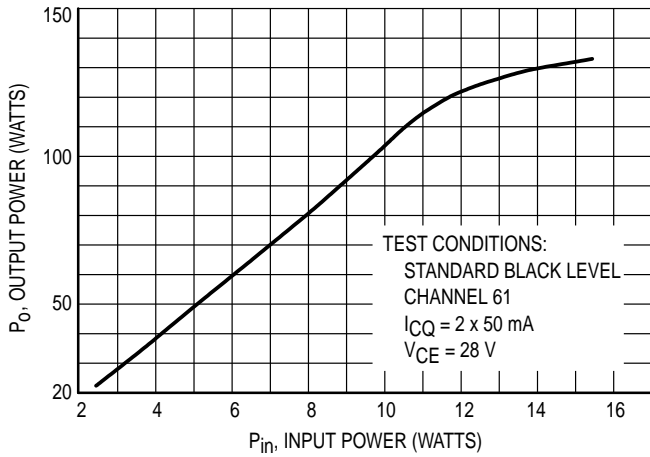
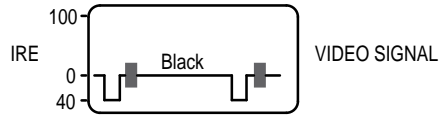

Figure 5. Peak Output Power versus Peak Input Power

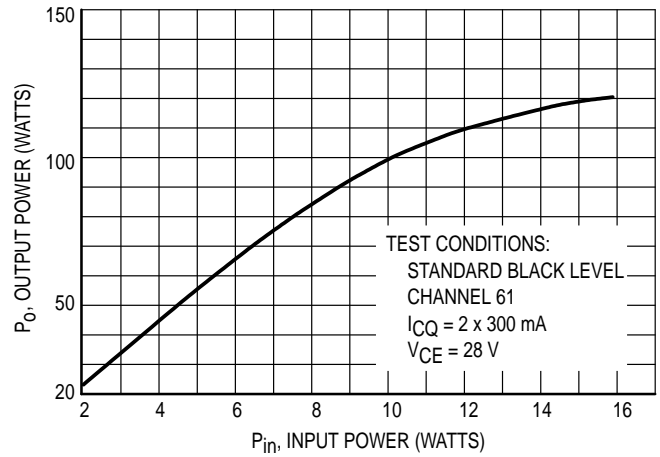

Figure 6. Peak Output Power versus Peak Input Power

TEST CONDITIONS:
 DIFF. Gain, 10 Steps
 Channel 61
 $V_{CE} = 28$ V

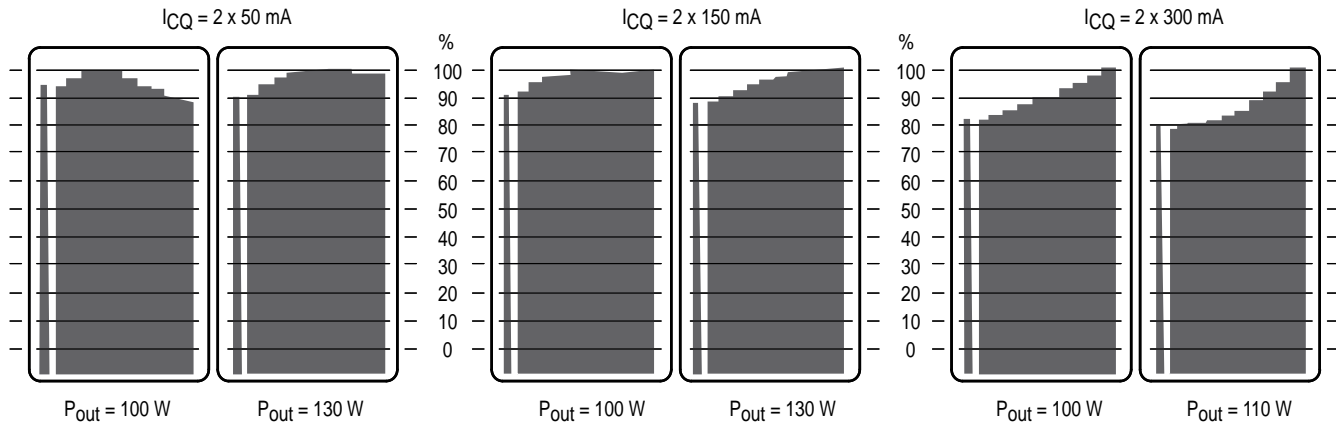
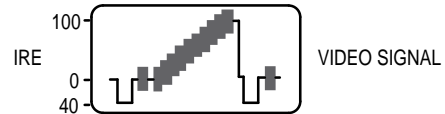

Figure 7. Gain versus Output Power

TYPICAL VIDEO CHARACTERISTICS @ $f = 800 \text{ MHz}$
 $V_{CE} = 32 \text{ V}$

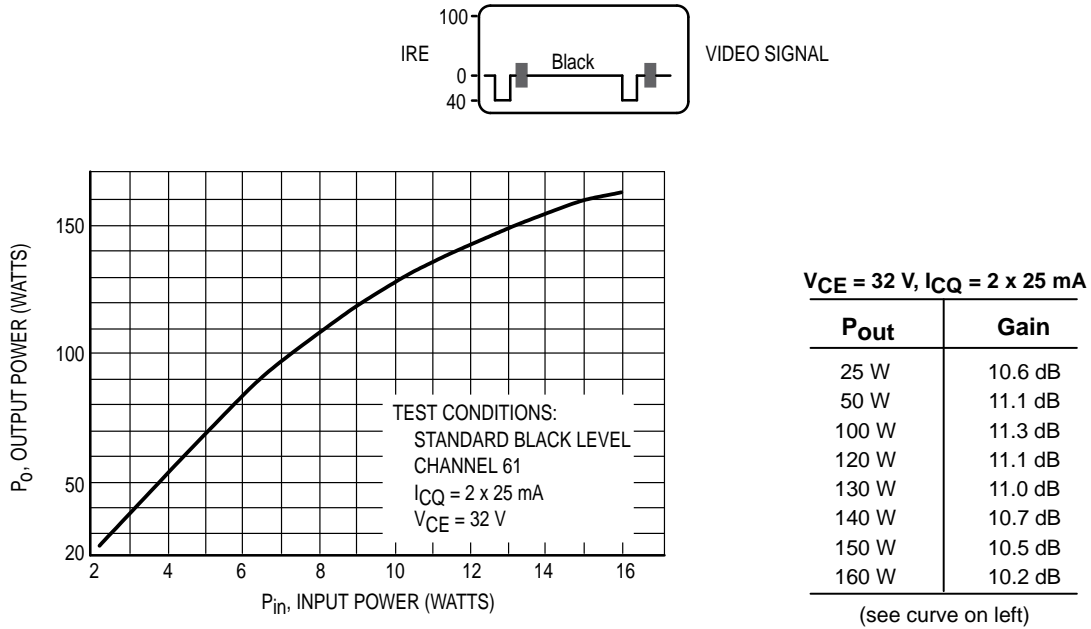

Figure 8. Peak Output Power versus Peak Input Power

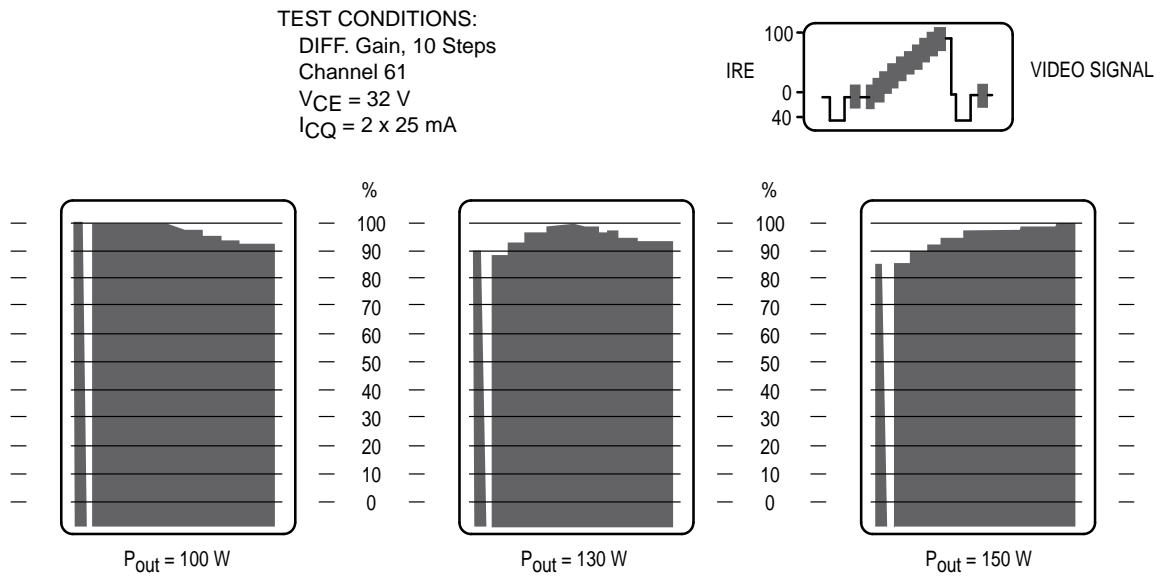

Figure 9. Differential Gain

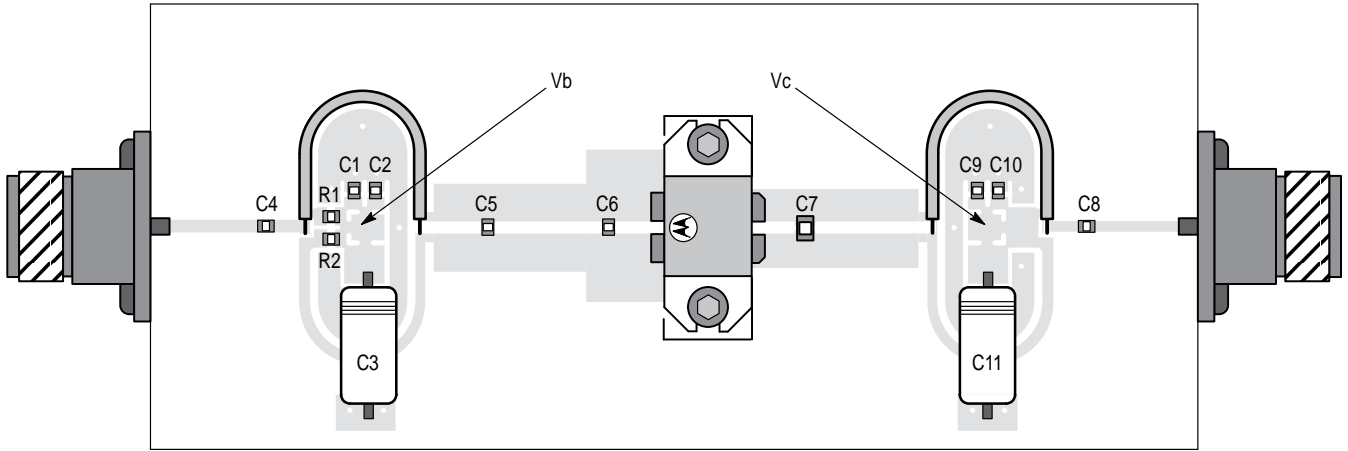
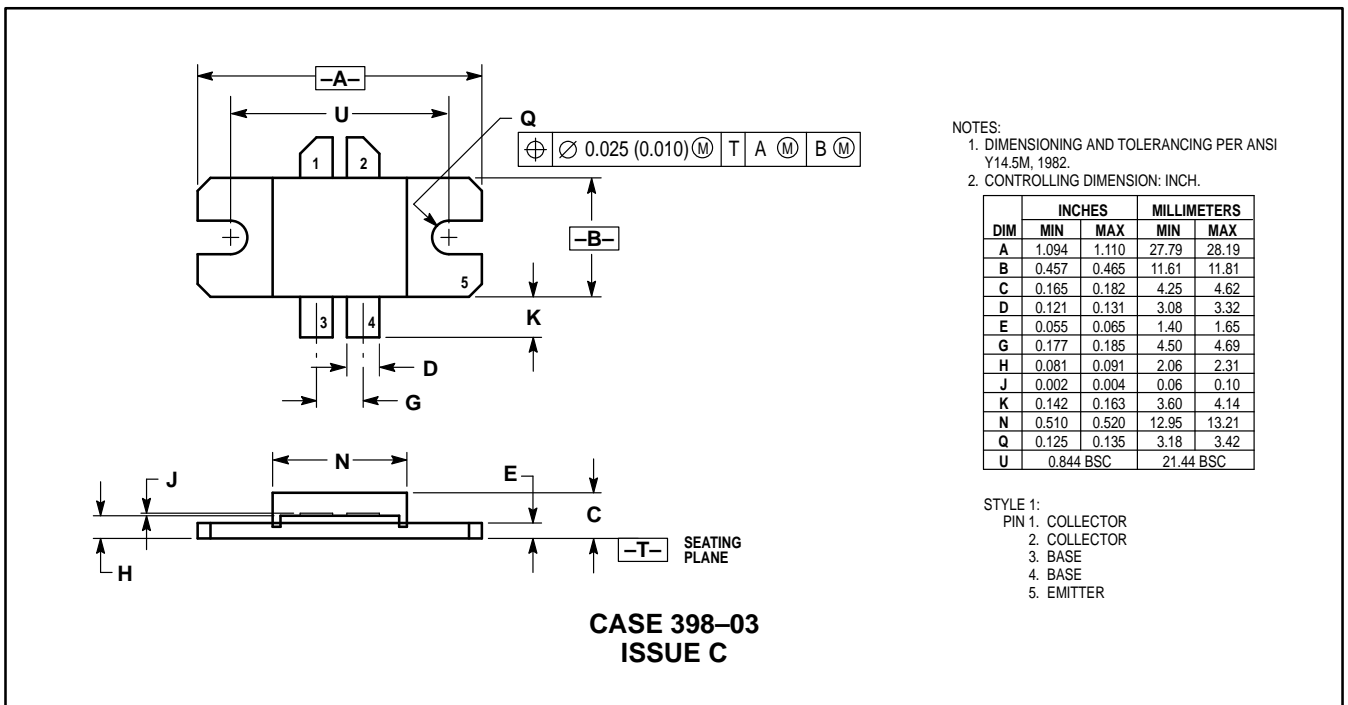

Figure 10. Components View

PACKAGE DIMENSIONS



Motorola reserves the right to make changes without further notice to any products herein. Motorola makes no warranty, representation or guarantee regarding the suitability of its products for any particular purpose, nor does Motorola assume any liability arising out of the application or use of any product or circuit, and specifically disclaims any and all liability, including without limitation consequential or incidental damages. "Typical" parameters can and do vary in different applications. All operating parameters, including "Typicals" must be validated for each customer application by customer's technical experts. Motorola does not convey any license under its patent rights nor the rights of others. Motorola products are not designed, intended, or authorized for use as components in systems intended for surgical implant into the body, or other applications intended to support or sustain life, or for any other application in which the failure of the Motorola product could create a situation where personal injury or death may occur. Should Buyer purchase or use Motorola products for any such unintended or unauthorized application, Buyer shall indemnify and hold Motorola and its officers, employees, subsidiaries, affiliates, and distributors harmless against all claims, costs, damages, and expenses, and reasonable attorney fees arising out of, directly or indirectly, any claim of personal injury or death associated with such unintended or unauthorized use, even if such claim alleges that Motorola was negligent regarding the design or manufacture of the part. Motorola and are registered trademarks of Motorola, Inc. Motorola, Inc. is an Equal Opportunity/Affirmative Action Employer.

Literature Distribution Centers:

USA: Motorola Literature Distribution; P.O. Box 20912; Phoenix, Arizona 85036.
 EUROPE: Motorola Ltd.; European Literature Centre; 88 Tanners Drive, Blakelands, Milton Keynes, MK14 5BP, England.
 JAPAN: Nippon Motorola Ltd.; 4-32-1, Nishi-Gotanda, Shinagawa-ku, Tokyo 141, Japan.
 ASIA PACIFIC: Motorola Semiconductors H.K. Ltd.; Silicon Harbour Center, No. 2 Dai King Street, Tai Po Industrial Estate, Tai Po, N.T., Hong Kong.



This datasheet has been download from:

www.datasheetcatalog.com

Datasheets for electronics components.